

Introduction to Measurements Systems LA-CoNGA physics - 2023

by Dennis Cazar Ramírez

February 6, 2023

- Actual Operational Amplifiers
- Finite Amplitude Gain
- Input Offset
- Bias current

Basic Definitions

Ideal and Real op-amps

Real op-amps differ from ideal in some important parameters

- **Open Loop Gain:** Very high, 100000 (100dB) for uA741 but not infinite. High bandwidth op-amps have much smaller open loop gain.
- **Offset Voltage:** An imbalance in input stage causes a *DC* voltage at the output when input is zero.
- **Bias Current:** Inputs do drain current (against the second golden rule).
- **Offset Current:** An offset of the two input currents will show up as a voltage offset at the output.

Operational Amplifiers

Ideal Op-amps

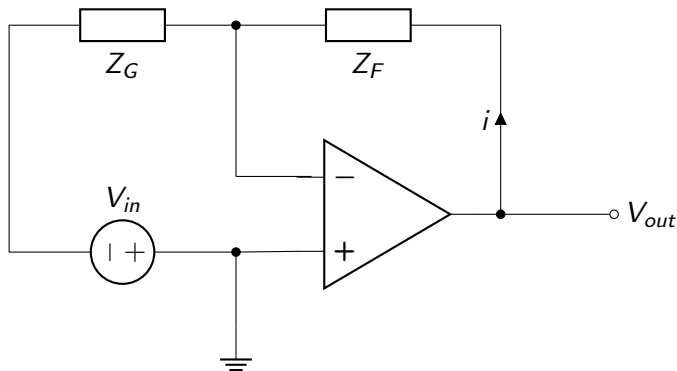

- Z_G and Z_F forms the β **network transfer function**
- The op-amp has Open Loop gain equal to A

Noise gain

- It is important to differentiate between **noise gain** and **signal gain** in an amplifier.

- Non inverting gain is

$$G = \frac{Z_F + Z_G}{Z_G} \quad (1)$$

- while Inverting gain is

$$G = \frac{1}{\beta} \quad (2)$$

- The feedback attenuation, β , is the same for both the inverting and non-inverting stages:

$$\beta = \frac{Z_G}{Z_G + Z_F} \quad (3)$$

Noise gain is the inverse of the net feedback attenuation from the amplifier output to the feedback input. In other words, the inverse of the β

- Including the β effects of finite op amp gain, a modified gain expression for the non-inverting stage is:

$$G_{CL} = \frac{1}{\beta} \left[1 + \frac{1}{1 + \frac{1}{A_{VOL}\beta}} \right] \quad (4)$$

- Where G_{CL} is the finite-gain stage's closed-loop gain and A_{VOL} is the op amp open-loop voltage gain for loaded conditions.
- For $A_{VOL}\beta \gg 1$

$$1 + \frac{1}{1 + \frac{1}{A_{VOL}\beta}} \approx \frac{1}{A_{VOL}\beta} \quad (5)$$

Gain Stability

- Closed-loop gain instability is produced primarily by variations in open-loop gain due to changes in supply voltage, temperature, loading, etc.

$$\frac{\Delta G_{CL}}{G_{CL}} \approx \frac{\Delta A_{VOL}}{A_{VOL}} \frac{1}{\beta} \quad (6)$$

- Any variation in open-loop gain ΔA_{VOL} is reduced by the factor $A_{VOL}\beta$, it is an effect on closed-loop gain.

This improvement in closed-loop gain stability is one of the important benefits of negative feedback.

Loop gain

- The product $A_{VOL}\beta$ is called **loop gain**
- for high values of $A_{VOL}\beta$ eq. (4) becomes:

$$\frac{A_{VOL}}{G_{CL}} \approx A_{VOL}\beta \quad (7)$$

- Consequently, in a given feedback circuit the loop gain, $A_{VOL}\beta$, is approximately the numeric ratio (or difference, in *dB*) of the amplifier open-loop gain to the circuit closed-loop gain.

Loop gain is a very significant factor in predicting the performance of closed-loop operational amplifier circuits.

Frequency Dependence of Loop Gain

- Open-loop gain is dependent of frequency!!

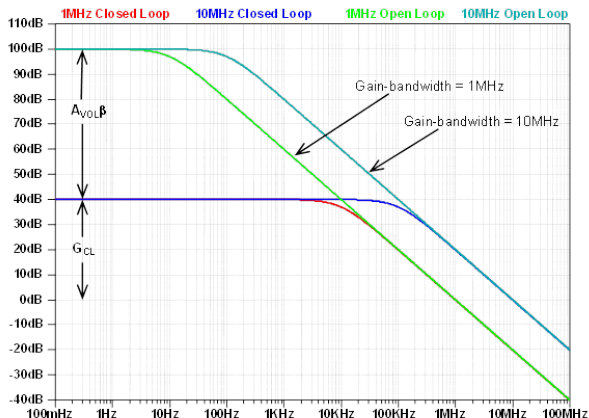

- In these Bode plots, subtraction on a logarithmic scale is equivalent to normal division of numeric data.

Gain-Bandwidth Product

If we multiply the open-loop gain by the frequency, the product is always a constant

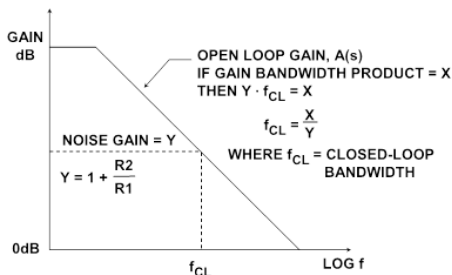

- For example, if we have an design which requires a closed-loop gain of 10 and a bandwidth of 100 kHz, we need an op amp with a minimum gain-bandwidth product of 1 MHz

Input Offset Voltage

- Ideally, if both inputs of an op amp are at exactly the same voltage, then the output should be at zero volts.
- In practice, a small differential voltage will need to be applied to the inputs to force the output to zero.

Input offset voltage is modeled as a voltage source, V_{OS} , in series with the inverting input terminal of the op amp

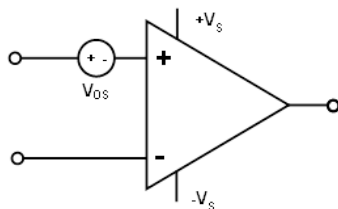

Offset Voltage Adjustment

- Many single op-amps have pins available for optional offset null pins.
- A simple configuration using a potentiometer (*uA741*)

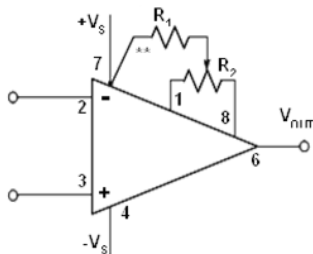

Be careful: the voltage gain of an op amp at its offset adjustment pins may actually be greater than the gain at its signal inputs!

Op Amp Input Bias Current

- Ideally, no current flows into the input terminals of an op amp.
- In practice, there are always two input bias currents, I_{B+} and I_{B-}

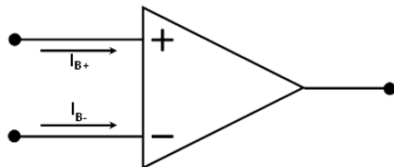

- I_B is a very variable parameter!
- I_B can vary from 60 fA (1 electron every 3 μ s) to many μ A, depending on the device.
- Some structures have well-matched I_B , others do not.

Input Offset Current

- The input offset current is defined as:

$$I_{OS} = I_{B+} - I_{B-} \quad (8)$$

- A bias compensation resistor can cancel the effects of bias current

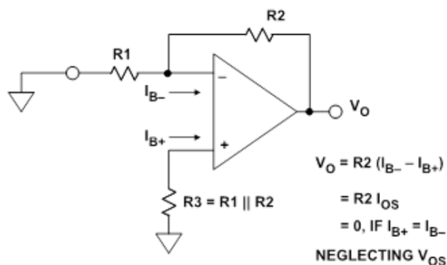

Input Bias current

- Input Bias Current (IB) refers to the DC currents flowing into or out of the amplifier's input pins to create a defined operating point during normal operation.

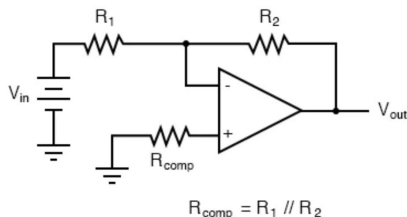

- For both inverting and non-inverting amplifier circuits, the bias current compensating resistor is placed in series with the non-inverting (+) input to compensate for bias current voltage drops in the divider network: